



Microcontroller

ENGINEERING REVIEW

Volume 5

Table of Contents

Environmental monitoring with the MAXQ3210	2
Security system control with the MAXQ2000	7

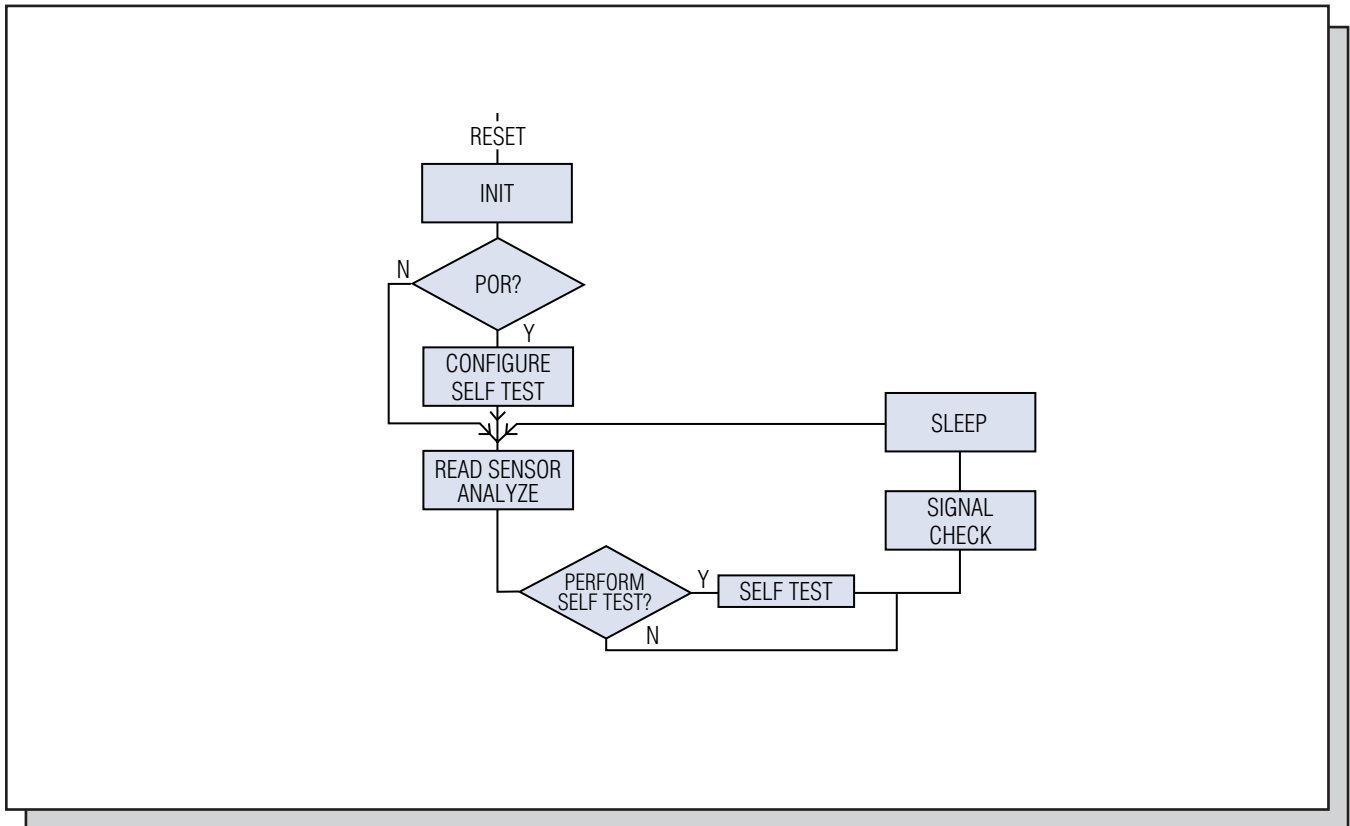

The MAX3210's main program loop in an environmental-sensing application spends most of its time in sleep mode, waking up periodically to read a sensor and analyze the results. (See page 3.)

Environmental monitoring with the MAXQ3210

The new MAXQ3210's capabilities make it unique in both the MAXQ family and the embedded microcontroller market. The MAXQ3210 integrates EEPROM code and data storage, a piezoelectric horn driver, and a 9V regulator into a low-pin-count package. A high-performance 16-bit RISC core makes the device both fast and power-friendly. Based on the MAXQ10 core, the MAXQ3210 differs from other MAXQ microcontrollers as it has 8-bit accumulators rather than 16-bit accumulators. The MAXQ3210 can be used in many applications where a few I/O pins and some smart control are required. This article describes some ideal environmental-monitoring applications.

MAXQ3210 features and monitoring capabilities

A high-performance 16-bit RISC core makes the MAXQ3210 both fast and power-friendly.

The MAXQ3210 has 2kB of EEPROM code space, 128 bytes of EEPROM data space, and 64 bytes of RAM. An integrated 9V regulator simplifies the circuit in battery-powered applications. The MAXQ3210 also provides a regulated 5V output for other circuit components. A JTAG debug engine allows in-application debugging without an expensive emulator.

The MAXQ3210 integrates unique peripherals that can be used in environmental-monitoring applications. A piezoelectric horn driver and high-current LED driver provide immediate status feedback when an environmental condition is unsafe or changing. These peripheral capabilities are useful in many monitoring applications; simple security systems, smoke alarms, temperature monitors, and motion detectors all have a place for a microcontroller that drives an electric horn.

Additionally, the device provides multiple options for interfacing to environmental-monitoring circuits. The MAXQ3210's internal analog comparator monitors voltage changes in external circuits, which occur as a result of environmental changes. This external circuit could be something as simple as a thermistor measuring temperature, or something more complex such as a slope analog-to-digital converter (ADC) that measures the amount of time a current takes to charge a capacitor.

Another option for monitoring external circuits is through the MAXQ3210's digital I/O. When an out-of-range condition occurs, for example, the environmental-monitoring circuit generates an external interrupt that awakens the MAXQ3210. The MAXQ3210's I/O pins could also use a serial transmission protocol to communicate data with an external IC that measures distance or lighting conditions.

Software architecture for a monitoring application

Applications written for the MAXQ3210 are generally small and simple enough to be coded in the MAXQ assembly language. For the example application presented later in this article, the MAX-IDE toolset is used. MAX-IDE is a free development environment from Dallas Semiconductor, providing an assembler and a debugging environment for MAXQ devices. **Figure 1** shows the basic architecture for an environmental-monitoring application.

On startup, the device passes through an initialization period in which registers and configuration bits are set for general application use. If the device was just powered on, extra operations may be required, such as manufacturing test and configuration. After passing through initialization and power-on check, the application enters the main loop where it measures and reacts to its environment. First, environmental readings are taken through the comparator or the digital I/O pins, and then analyzed for out-of-range conditions. Next, the application performs periodic diagnostics, which may include testing external circuits, measuring the battery, or checking for permanent faults recorded in the data EEPROM. Following the diagnostics, the application checks the status, which can range from warnings (low battery) to alert conditions (temperature too high). When the environmental readings require action, the application has several options that we discuss below: sound a horn, flash an LED, use the I/O pins to communicate with another device, or simply record the condition into the data EEPROM for later analysis.

Software for a simple monitoring application

A simple application that models an environmental monitor is available online at www.maxim-ic.com/MAXQ3210_Environment. It was built and tested on the MAXQ3210 evaluation kit. A pushbutton toggles between alarming and normal conditions. The horn sounds to indicate an alarm.

The main loop of the environmental-monitoring application appears in the following paragraph. Notice that the state machine for an environmental monitor is very simple; it takes sensor readings and analyzes them to see if the system has exceeded some threshold (temperature too hot, too much smoke in the air, etc.). If the condition is out of bounds, an alarm signals.

MainLoop:

```

move DP[0], #CONDITION_FLAG      ; see if we are alarming
move ACC, @DP[0]                 ; read the alarm flag
jump z, MainLoop_NoSignal        ; skip next code if not alarming

```

```
;
```

```

; If our condition is above threshold, see if it is
; time to sound the horn

```

```
;
```

```

call CheckSignalTime             ; see if it is time to sound the horn
jump nz, ReadAndSleep            ; back to sleep if no signal
call SignalCondition              ; sound horn, light LEDs, etc.
jump ReadAndSleep                ; let's go to sleep now

```

```
;
```

```

; In a real sensor, we still want to take readings even if we are
; signaling. We need to check to see if environmental conditions
; have returned to normal.

```

```
;
```

MainLoop_NoSignal:

```

call CheckForSelfTest            ; time to run periodic diagnostics?
jump z, ReadAndSleep            ; skip if not time yet
call SelfTest                    ; perform self diagnostics

```

ReadAndSleep:

```

call ReadSensor                  ; get a 'sensor reading'
call AnalyzeSensor               ; see if condition out of threshold
jump Sleep                       ; put the device into low power mode

```

The `SelfTest` function allows periodic system diagnostics, in which applications could monitor their battery condition or check for misbehaving circuits. `SelfTest` is also a good place to increment an internal timer to track how long the MAXQ3210 has been active, thereby allowing the external systems with sensors that degrade over time to have a planned end-of-life.

The application code demonstrates how MAXQ peripherals are easy to use, and how they conserve code space and execution cycles. For instance, the horn driver only requires a single bit to activate or deactivate the horn output.

SoundTheHorn:

```

move HORN_DRIVER, #1
move LC[0], #10
call DelayMilliseconds
move HORN_DRIVER, #0
ret

```

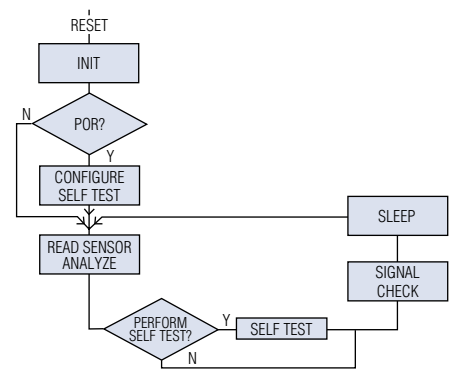

Figure 1. The MAX3210's main program loop in an environmental-sensing application spends most of its time in sleep mode, waking up periodically to read a sensor and analyze the results.

With its data EEPROM, a 16-bit timer that supports capture, compare, and PWM operations, and high-performance MAXQ microcontroller core, the MAXQ3210 is useful for a wide range of microcontroller applications.

The single-cycle MAXQ core and large register space allow applications to store data efficiently and perform computations quickly. The MAXQ3210 spends more time in low-power sleep mode and less time executing code.

Power management

Power consumption is one of the most important factors in environmental-monitoring applications, which typically run off a battery. The MAXQ3210 provides a low-power stop mode and a low-voltage battery monitor.

When the application is periodically measuring an environmental condition, the MAXQ3210's low-power stop mode has two options for wakeup: an external interrupt or a wakeup timer that can bring the device out of sleep mode and begin code execution. The external interrupt is a good option when the application is waiting for an external circuit to trigger a condition. Typical examples are waiting for a door to open or the voltage across a thermistor to cross a threshold for the external interrupt.

The wakeup timer is another option for bringing the MAXQ3210 out of stop mode. Wakeup is the function discussed earlier in the demo application: the external monitoring circuit wakes up the MAX3210, which measures the environment, reacts if necessary, and then returns to sleep.

Figure 2 shows the typical current-consumption model for such an application. Most of the microcontroller's time is spent in low-power sleep mode. When the device does wake up, the

current consumption is much higher. This is where the high performance of the MAXQ core is useful. The MAXQ3210 performs its computations quickly, spending less time in the high-power consumption state and more time in low-power sleep mode.

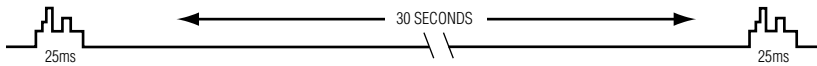

Figure 2. Monitoring applications sleep most of the time to conserve power, waking up periodically for very short runtimes.

Because battery life is a crucial component of most monitoring applications, it is useful to detect when a battery is nearing end of life. The MAXQ3210 determines if battery voltage has fallen below a threshold by simply checking a status bit in a register. This voltage threshold is fixed at 7.7V, which is where 9V batteries begin to break down. At this voltage level, there is ample power left in the battery for the MAXQ3210 to continue to run. A power-conscious application can run for days or weeks on a low battery and issue periodic warning signals, as is commonly done in smoke alarms.

Data EEPROM

The MAXQ3210's 128-byte data EEPROM makes an application smarter. It allows applications to keep permanent configuration and status data, even across power failures or battery removals. Permanent data storage is useful for several purposes.

- 1) *Yield improvements.* Devices that behave slightly outside specification (for instance, a distance detector that measures a little short) can store permanent configuration information, allowing software to compensate for an external circuit's variations. This allows end devices to be activated or sold that might have previously been discarded.
- 2) *Behavioral configuration and customization.* MAXQ3210 applications can be customized for their specific target environments or end users. For example, an environmental-monitoring application might be configured as part of a larger network. When the device's measurement is triggered at some threshold, not only would the microcontroller sound its horn, but it could also toggle port pins to alert other devices about the condition. Factory configuration can enable or disable this network notification.
- 3) *End of life.* In an environmental sensor, the circuit measuring the environment might degrade with use. By updating the EEPROM of the MAX3210 as time passes, an application has control over how long it runs before it must be replaced. A sensor, for example, after five years of running can automatically disable itself, signaling with a horn or flashing LED that it is no longer functional.

Environmental-monitoring applications

Some of the more obvious environmental-monitoring applications for the MAXQ3210 are home-safety applications: fire alarms and gas alarms. The MAXQ3210 has all the tools to implement these applications integrated on-chip. The MAXQ3210 is, however, far more versatile than a dedicated smoke-alarm microcontroller. A variety of applications can be created using the simple environment-monitoring software architecture previously discussed. Some of the following examples target safety applications that prevent or minimize damage to businesses or homes. Other applications provide convenience to the consumer.

To prevent damage to the home or office, one application is a water-level monitor for a basement, where a build-up of water might not be noticed for some time. In this case, water is detected with a humidity sensor or a tank apparatus similar to what is used in a toilet. When the water causes the float to rise above a certain point, the float triggers an external interrupt, and the MAXQ3210 sounds an electric horn to alert residents. In addition, the MAXQ3210 communicates the situation to a larger home or business network, which in turn notifies the business or homeowner about the condition.

Temperature monitoring is another potential application. The contents of a supermarket freezer or a refrigerated car on a delivery truck are monitored for excessive heat. A simple thermistor is used along with the analog comparator; when the temperature of a food cooler exceeds safe limits, the MAXQ3210 indicates the condition to a clerk in the grocery store. This local temperature monitoring has endless useful applications, such as network equipment, beverages, film, laboratory equipment, art supplies, and virtually any perishable product.

Applications can also be about convenience. The MAXQ3210 in a smart motion detector alerts a homeowner when a pet, child, or intruder enters an area of the house that is off-limits. Pushbuttons are used to configure the sensor.

The MAXQ3210 is a natural fit as a parking assistant. Using a simple distance-detection circuit, the MAXQ3210 sounds its horn for different durations depending on the distance measured. This application requires configuration and intelligence in the microcontroller. When placed in the garage, this circuit helps owners park their cars without bumping into the walls. An end user might not want their automated parking assistant sounding the electric horn each time they walk in front of the circuit. Consequently, the device is programmed with an initial delay—when motion is first detected, the system waits two seconds to see if any additional motion is detected. If not, the motion was probably someone walking in front of the sensor. Also, the device could be disabled through the use of pushbuttons; it would be inconvenient if the device constantly beeped while the end user worked in the garage.

Evaluation kit

The MAXQ3210 evaluation kit (EV kit) is an excellent platform to begin prototyping any MAXQ3210 application. It runs off a 9V supply or a 9V battery. Two pushbuttons control the reset and external interrupt signals. A 10-pin JTAG header provides access to hardware debugging routines, thereby allowing viewing and modification of registers, memory, and stack. The I/O pins are connected to a convenient 2 x 20 header, close to a prototyping area for testing external circuits.

An on-board piezoelectric horn and LED can be used to test the sights and sounds of the application. By default, the horn outputs a damped sound—loud, but not painful. Jumpers can be added to the board to short the dampening circuit, allowing the horn to be driven at its full 85dB volume.

The MAXQ3210 EV kit can be used with MAX-IDE. It supports the hardware debug engine of the MAXQ3210, providing source-code-level debugging and memory monitoring.

The MAXQ3210 has a 128-byte data EEPROM that makes an application smarter. This EEPROM allows applications to keep permanent configuration and status data, even across power failures or battery removals.

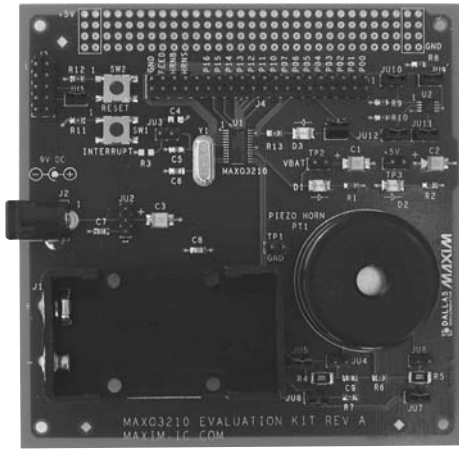

Figure 3. The MAXQ3210 evaluation kit provides a piezoelectric horn, LEDs, and a 9V battery holder for complete application development.

MAXQ3210 benefits summary

As we have seen, the MAXQ3210 has several advantages for environmental-monitoring applications. The primary advantage is integration—components required by monitoring applications (comparator, horn, and LED driver) are integrated onto the chip, eliminating the need for external chips to drive these functions. Integration lowers the overall system cost and improves reliability by reducing the number of components that need to be tested. Plus, a single chip requires fewer connections, lowering the test time for the end circuit board. The single-chip solution also means smaller and less expensive PC boards.

Additional microcontroller benefits are high performance and low-power consumption. The single-cycle MAXQ core and large register space allow applications to store data efficiently and perform computations quickly. The MAXQ3210 spends more time in low-power sleep mode and less time executing code.

Finally, the MAXQ3210's battery monitor and data EEPROM allow smart, self-monitoring applications. Devices can warn the user when their battery is nearing depletion. In addition, applications can track the life of their components and implement a planned end-of-life.

Conclusion

The MAXQ3210 is a low-pin-count implementation of a MAXQ microcontroller, designed for applications that do not require the peripheral support provided by more expensive microcontrollers. While the MAXQ3210 is an excellent fit for environmental sensors, it is truly a general-purpose, high-performance, power-saving microcontroller, capable of adding intelligence and interaction to many applications.

It is important to note that while this article discusses environmental monitoring, the MAXQ3210's applications are far broader. With its data EEPROM, a 16-bit timer that supports capture, compare, and PWM operations, and high-performance MAXQ microcontroller core, the MAXQ3210 is useful for a wide range of microcontroller applications.

Security system control with the MAXQ2000

Common alarm-control panels contain several input devices and require user displays. The usual components for these systems include:

- A device to accept input from the user: a 4 x 4 switch keypad.
- A device to display output to the user: an LCD display.
- An input device: a magnetic reed switch.
- An output device: a piezoelectric horn.

A small piezoelectric horn can be interfaced with the MAXQ2000 by connecting it between two port pins.

These several components can be managed and controlled by a simple application and the powerful, flexible MAXQ2000 microcontroller. This application, available online at www.maxim-ic.com/MAXQ2000_Alarm, was written in MAXQ assembly language using the MAX-IDE development environment. The code was targeted for the MAXQ2000 evaluation kit board, using the following additional hardware:

- Keypad: Grayhill 16-button (4 rows by 4 columns) keypad 96BB2-006-F
- Piezoelectric horn: CEP-1172
- Magnetic reed switch: standard single-loop type

Design goals

Our example application performs the following tasks:

- Monitors the magnetic reed switch to determine if a door/window is open or closed.
- Allows the user to arm or disarm the system by entering a PIN on the keypad.
- Displays status information to the user on the LCD.
- Provides audio indications of keypresses and sensor open/close events by sounding the piezoelectric horn.
- Sounds the horn continuously if the sensor is opened while the system is armed.

The behavior of the alarm control application consists of four discrete states: CLOSED, OPEN, SET, and ALERT (**Figure 1**).

Interfacing to the magnetic reed switch

In an alarm system, magnetic reed switches are installed in two parts: a magnet and the actual reed switch. The magnet portion is placed on the moving section of a door or window, while the switch portion is placed on the frame. When the door or window is closed, the magnet closes the reed switch, indicating a nonalarming condition. If the system is armed and the window or door is opened, the reed switch changes state, allowing the MAXQ2000 to sound an intrusion alert.

In an alarm system, magnetic reed switches are installed in two parts: a magnet and the actual reed switch.

The reed switch is interfaced to the MAXQ2000 simply by connecting it between port pins P5.2 and P5.3. With P5.2 set to an active-low pulldown (PD = 1, PO = 0) and P5.3 set to a weak pullup input (PD = 0, PO = 1), P5.3 will read zero when the reed switch is closed and one when the reed switch is open.

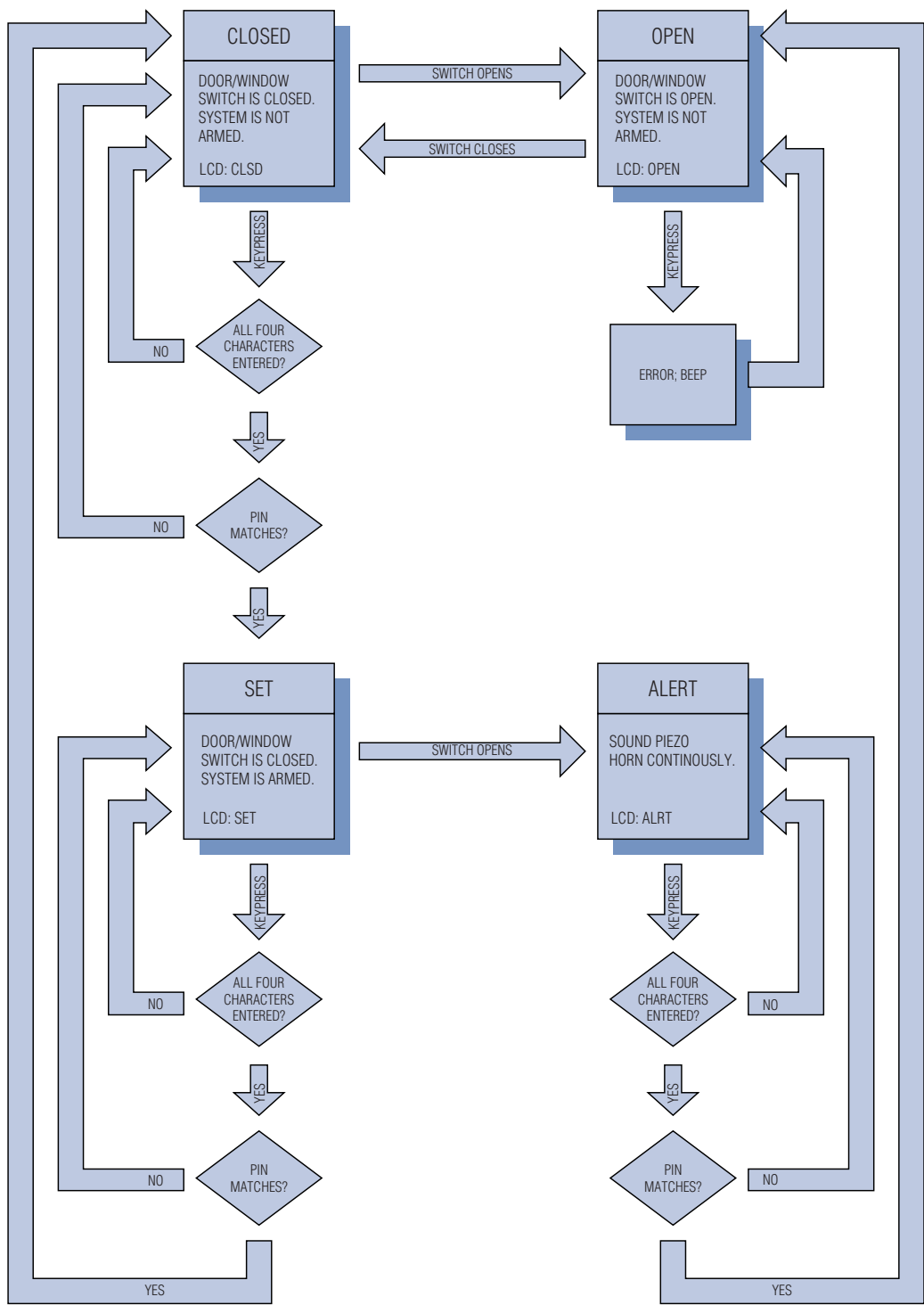

Figure 1. The alarm control application operates in four main states: CLOSED, OPEN, SET, AND ALERT.

Interfacing to the 4 x 4 keypad

Keypads are used in alarm control systems for secure PIN entry, to arm/disarm the system, and to change configurations. The keypad used in this example application consists of 16 switches, organized in a 4 x 4 grid. The switches are tied together in a row and column matrix (**Figure 2**) so that depressing a keypad switch connects one row line to one column line. For example, depressing the “3” key connects row 1 and column 3 together.

The keypad provides eight interface pins, one pin for each row and column of the keypad matrix. The keypad and the MAXQ2000 EV kit are connected as shown.

Pin	1	2	3	4	5	6	7	8
Connect	Row 1	Row 2	Row 3	Row 4	Col 1	Col 2	Col 3	Col 4
Port Pin	P6.0	P6.1	P6.2	P6.3	P6.4	P6.5	P6.6	P6.7
JU2 Pin	54	52	50	48	46	44	42	40

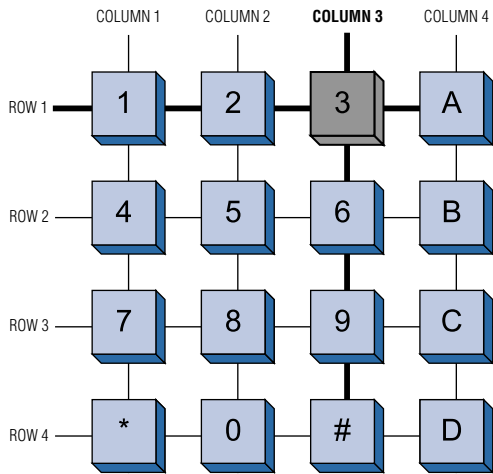

Figure 2. The keypad switches form a grid of four rows and four columns.

For this application, the EV kit board should be configured as described below.

- DIP switches
 - The following switches must be OFF: all SW1 switches, SW3.1, SW3.7, SW3.8, SW6.1, SW6.4, SW6.5, SW6.6, SW6.7, and SW6.8.
 - All other DIP switches can be in any state.
- Jumpers
 - The following jumpers must be OPEN: JU5, JU6, JU8, and JU9.
 - The following jumpers must be CLOSED: JU1, JU2, JU3 and JU11.
 - All other jumpers can be in any state.

Scanning by columns

The row and column arrangement of the keypad makes it easy to read the state of four switches at any one time, on either a row or column basis. To read four switches in one column, first the line for that column must be pulled low, and all other columns tri-stated (**Figure 3**). Next, a weak pullup must be set on each row line. Finally, the four row lines are connected to port pin inputs. The input from a row will be low when the switch on that row is depressed, and high otherwise.

Similarly, the state of four switches in a row can be read by pulling that row line low and setting inputs and weak pullups on all four columns. The rows and columns are interchangeable.

In our setup, the four row lines (keypad pins 1 through 4) are all connected to the same input port (P6[3:0]), which makes it easier to read them simultaneously. For this reason, the example application scans one column of switches at a time.

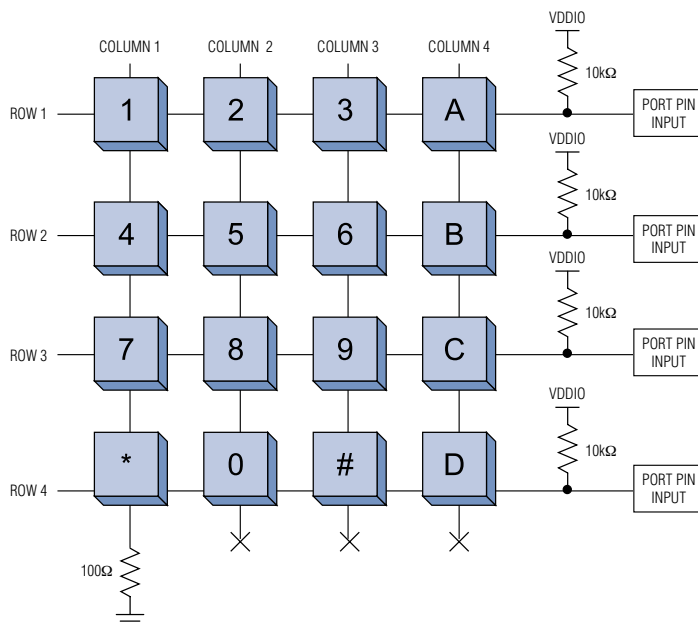

Figure 3. The MAXQ2000 pulls column 1 low to read the state of the first four keypad switches.

There are four setup states (see table below) for the eight port-pin lines connected to the keypad, each of which allows four of the switches to be read. All input lines read low when the switch being read is closed, and high when the switch is open.

With the row and column arrangement of the keypad, it is possible to read the state of four switches at any one time.

STATE	P6.0	P6.1	P6.2	P6.3	P6.4	P6.5	P7.0	P7.1
1	Input - 1	Input - 4	Input - 7	Input - *	low	tri-state	tri-state	tri-state
2	Input - 2	Input - 5	Input - 8	Input - 0	tri-state	low	tri-state	tri-state
3	Input - 3	Input - 6	Input - 9	Input - #	tri-state	tri-state	low	tri-state
4	Input - A	Input - B	Input - C	Input - D	tri-state	tri-state	tri-state	low

An interrupt-driven state machine

The four columns must be strobed quickly so that any keypress has time to be read before it is released. Additionally, to prevent a switch's bouncing contacts from registering multiple presses, a key must be held down for a certain amount of time before it registers. Both of these factors can be done at once by making a timer-driven interrupt routine the heart of the application. This allows the application to scan through each one of the four columns in a periodic manner and to count the length of time a key has been depressed.

The reload value for the timer controls how often the interrupt will fire. This value must be short enough so that all keypresses are recognized. Additionally, to ensure that key response is not sluggish, the reload value must also be long enough so that it does not occupy an excessive amount of processing time. The value 0FF00h used in the example application code (once about every 2.4ms) was reached through experimentation.

Once the column line for a group of four switches is driven low, some time may be required for the connection operating through a depressed switch to pull its input line low. This time is affected by the switch's on-resistance and by how many column switches are depressed at once. To avoid having to delay the interrupt service routine between pulling the column line low and reading the four switches, the column line for a given state is driven low in the previous state (Figure 4).

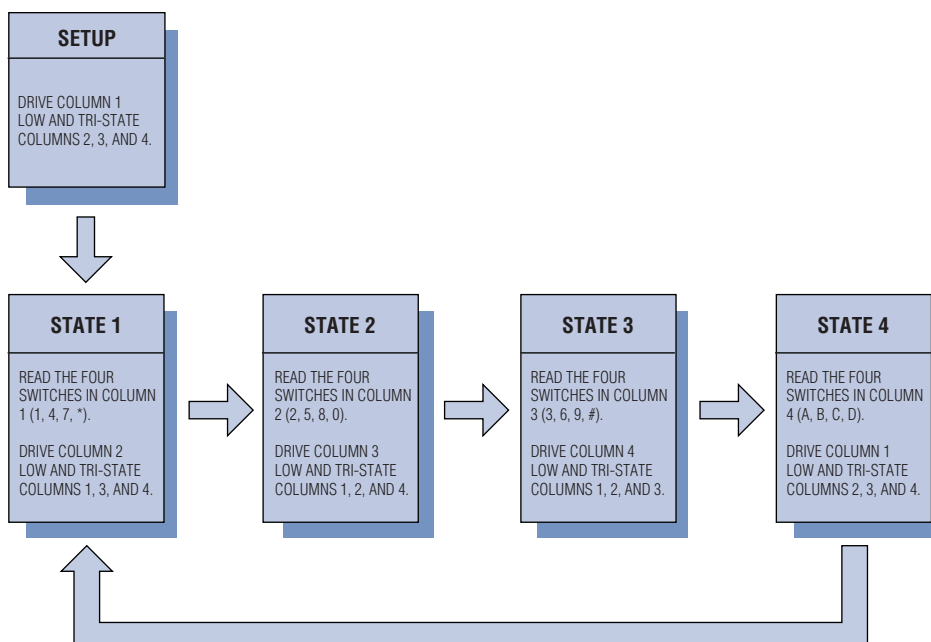

Figure 4. In each of the four key-scanning states, the application reads the status of four switches and prepares to read the next four.

In the CLOSED, SET, and ALERT states, a PIN can be entered to change the alarm controller to another state.

Because the interrupt vector (IV) for the MAXQ2000 can be set on-the-fly, the application holds the next-state value in the interrupt vector register. Whenever the timer interrupt fires, the handler routine for the current key-scanning state sets the interrupt vector address to the next state's handler routine.

The handler routines for the other four states are similar, with a slight adjustment to OR in the previously collected switch bits in the A[13] holding register. There are three working accumulators used by the state routines.

A[13] holds the bit array of all the switch states read on the current pass through the keypad. After the State 4 read completes, this register contains the following bits, where a one bit represents an open (released) key switch and a zero bit represents a closed (depressed) key switch.

BIT 15	BIT 14	BIT 13	BIT 12	BIT 11	BIT 10	BIT 9	BIT 8	BIT 7	BIT 6	BIT 5	BIT 4	BIT 3	BIT 2	BIT 1	BIT 0
*	7	4	1	2	5	8	0	3	6	9	#	D	C	B	A

Debouncing switches

After State 4 is reached and all keys are scanned, a decision must be made whether to accept any keys that are pressed. A simple way to handle debouncing is to maintain a counter value for each of the 16 switches. Every time State 4 is reached and the key is pressed, the counter is incremented. If the key is not pressed, the counter is decremented. When the counter reaches a certain value, the keypress is registered. To prevent a held-down key from repeating (which typically is allowed on computer keyboards, but not on keypads), the counter must be allowed to decrement back to zero (by releasing the key) before that key may be registered again.

As we have the state of all 16 keys in a single register, there is a simpler, less memory-intensive solution for debouncing. The application maintains a single counter value that is incremented each time the bit pattern matches the pattern read on the previous pass.

To prevent keys from repeating, once a bit pattern has been static long enough to be accepted, a different bit pattern (which includes the idle state where no keys are depressed) must be accepted before the first bit pattern can be accepted again.

Handling simultaneous keypresses

Simultaneous keypresses are possible when using a keypad input device. The debouncing code ensures that if a second key is pressed right after the first, the debounce interval will start over, but be short enough in practice so that this is not an issue.

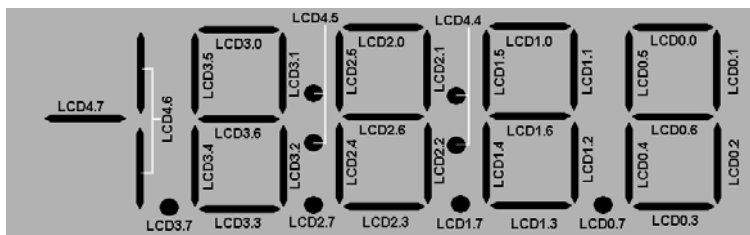

Figure 5. The LCD display contains four-and-a-half 7-segment characters.

Once a bit pattern has been accepted, the action for each depressed-key bit can be taken by rotating all 16 bits into the carry bit individually using the accumulator and checking each in turn. The example application code responds only to the first depressed key, but this could be easily changed.

Interfacing to the LCD display

The LCD display included with the MAXQ2000 EV kit has segments defined as shown (Figure 5).

First, the LCD display must be initialized to static drive mode and enabled. Once this has been done, characters can be written to the display by setting segments appropriately.

Entering the PIN

In the CLOSED, SET, and ALERT states, a PIN can be entered to change the alarm controller to another state. As each character is entered, the working value held in A[10] is shifted left and ORed with the new character, and the decimal point on the LCD display moves left to indicate the number of characters entered. For security reasons, the PIN being entered is not shown on the display.

Once all four characters are entered, the PIN is checked against a hard-coded value. If the entered value matches the PIN, the appropriate state transition occurs.

Using the piezoelectric horn

In our application, a small piezoelectric horn is used to perform two functions: (1) provide audio feedback when keys are pressed or when an incorrect PIN is entered, and (2) sound an alarm when the reed switch opens while the system is armed.

For demonstration purposes, a small piezoelectric horn can be interfaced with the MAXQ2000 by connecting it between two port pins. The port pins are driven differentially to increase the current drive to the piezoelectric horn, and the loop counts used in the driver code determine the frequency of the tone emitted.

In an actual alarm system, stronger drive circuitry would be used to run the piezoelectric horn, and the horn would be driven at its resonant frequency to increase the volume.

Conclusion

The MAXQ2000 interfaces easily and directly to LCD displays by means of its dedicated LCD controller peripheral. Multiplexed keypads can be read in a straightforward manner using the flexible port-pin configuration provided by the MAXQ2000. A timer-interrupt-driven state machine allows all keys in the matrix to be scanned and debounced with minimal effect on processor overhead. Finally, a piezoelectric horn and magnetic reed switch can be controlled easily as well, using the general-purpose port pins available on the MAXQ2000.

***The MAXQ2000
interfaces easily and
directly to LCD displays
by means of its
dedicated LCD controller
peripheral.***