

GPS/GNSS Low-Noise Amplifier

General Description

The MAX2659 high-gain, low-noise amplifier (LNA) is designed for GPS, Galileo, and GLONASS applications. Designed in Maxim's advanced SiGe process, the device achieves a 20.5dB gain and an ultra-low-noise figure of 0.8dB while maximizing the input-referred 1dB compression point and the 3rd-order intercept point at -12dBm and -5dBm, respectively.

The MAX2659 operates from a +1.6V to +3.3V single supply and consumes only 4.1mA. The shutdown feature in the device reduces the supply current to be less than 1 μ A. The MAX2659 is available in a very small, lead-free, RoHS-compliant, 1.5mm x 1.0mm x 0.75mm, 6-pin μ DFN package.

Applications

Automotive Navigation
Location-Enabled Mobile Devices
Telematics (Asset Tracking and Management)
Personal Navigation Device (PND)
Cellular Phones with GPS
Notebook PC/Ultra-Mobile PC
Recreational, Marine Navigation
Avionics

Features

- ◆ High-Power Gain: 20.5dB
- ◆ Ultra-Low-Noise Figure: 0.8dB
- ◆ Integrated 50 Ω Output Matching Circuit
- ◆ Low Supply Current: 4.1mA
- ◆ Wide Supply Voltage Range: 1.6V to 3.3V
- ◆ Low Bill of Materials
- ◆ Small Footprint: 1.5mm x 1.0mm
- ◆ Thin Profile: 0.75mm
- ◆ Lead-Free and RoHS-Compliant Package

Ordering Information

PART	TEMP RANGE	PIN-PACKAGE
MAX2659ELT+	-40°C to +85°C	6 μ DFN

+Denotes a lead-free package.

Pin Diagram/Functional Diagram/Typical Application Circuit

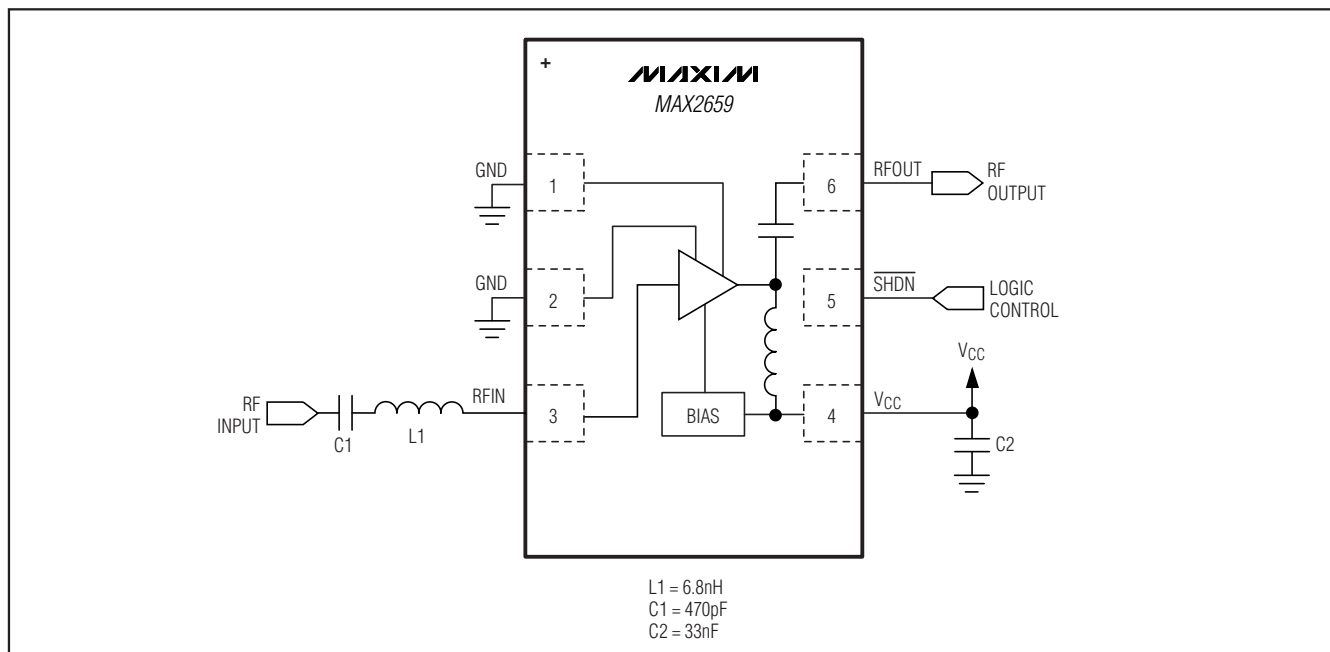

GPS/GNSS Low-Noise Amplifier

ABSOLUTE MAXIMUM RATINGS

V_{CC} to GND-0.3V to +4.2V
 Other Pins to GND.....-0.3V to + Operating V_{CC} + 0.3V
 Maximum RF Input Power+10dBm
 Continuous Power Dissipation (T_A = +70°C)
 6-Pin µDFN (derates 2.1mW/°C above +70°C).....167mW

Operating Temperature Range-40°C to +85°C
 Junction Temperature.....+150°C
 Storage Temperature Range-65°C to +160°C
 Lead Temperature (soldering, 10s).....+260°C

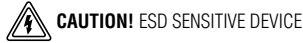

Stresses beyond those listed under "Absolute Maximum Ratings" may cause permanent damage to the device. These are stress ratings only, and functional operation of the device at these or any other conditions beyond those indicated in the operational sections of the specifications is not implied. Exposure to absolute maximum rating conditions for extended periods may affect device reliability.

DC ELECTRICAL CHARACTERISTICS

(MAX2659 EV kit; V_{CC} = 1.6V to 3.3V, T_A = -40°C to +85°C, no RF signals are applied. Typical values are at V_{CC} = 2.85V and T_A = +25°C, unless otherwise noted.) (Note 1)

PARAMETER	CONDITIONS	MIN	TYP	MAX	UNITS
Supply Voltage		1.6	2.85	3.3	V
Supply Current	$\overline{\text{SHDN}}$ = high		4.1	5.6	mA
	Shutdown mode, $\overline{\text{SHDN}}$ = low			1	µA
Digital Input-Logic High		1.1			V
Digital Input-Logic Low				0.4	V
Digital Input Current				1	µA
RFIN DC Voltage	$\overline{\text{SHDN}}$ = high		0.83		V

AC ELECTRICAL CHARACTERISTICS

(MAX2659 EV kit; V_{CC} = 1.6V to 3.3V, T_A = -40°C to +85°C, f_{RFIN} = 1575.42MHz. Typical values are at V_{CC} = 2.85V and T_A = +25°C, unless otherwise noted.) (Note 1)

PARAMETER	CONDITIONS	MIN	TYP	MAX	UNITS
RF Frequency	L1 band		1575.42		MHz
Power Gain	V _{CC} = 2.85V	17	20.5		dB
	V _{CC} = 1.6V	16.5	20.5		
Noise Figure	(Note 2)		0.8		dB
3rd-Order Input Intercept Point	(Note 3)		-5		dBm
Input 1dB Compression point	(Note 4)		-12		dBm
Input Return Loss	(Note 2)	10	15		dB
Output Return Loss	(Note 2)	10	25		dB
Reverse Isolation	(Note 2)		32		dB

Note 1: Min and Max limits guaranteed by test at T_A = +25°C and guaranteed by design and characterization at T_A = -40°C and T_A = +85°C.

Note 2: Guaranteed by design and characterization.

Note 3: Measured with the two tones located at 5MHz and 10MHz offset from the center of the GPS band with -40dBm/tone.

Note 4: Measured with a tone located at 5MHz offset from the center of the GPS band.

GPS/GNSS Low-Noise Amplifier

MAX2659

Typical Operating Characteristics

(MAX2659 EV kit; Typical values are at $V_{CC} = 2.85V$, $T_A = +25^\circ C$, and $f_{RFIN} = 1575.42MHz$, unless otherwise noted.)

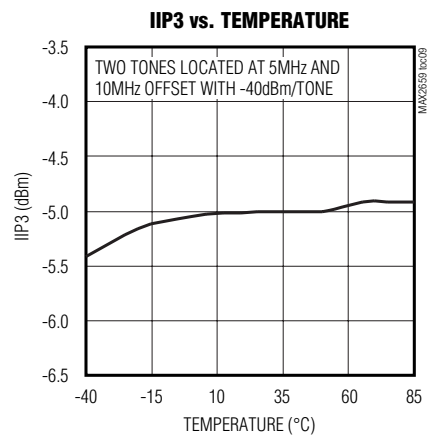
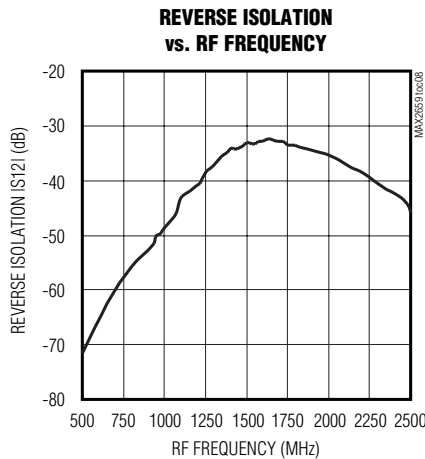
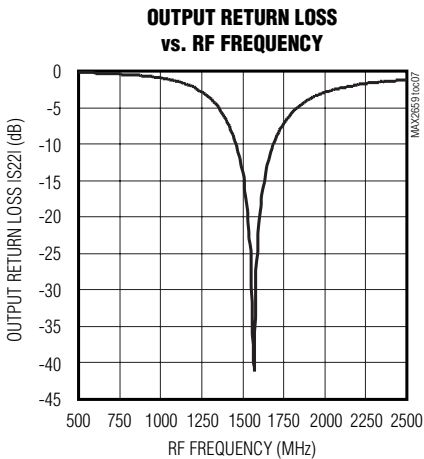
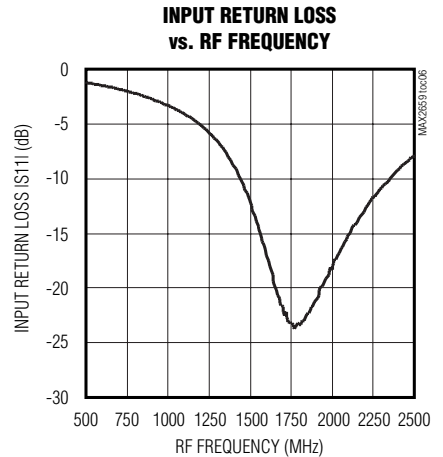
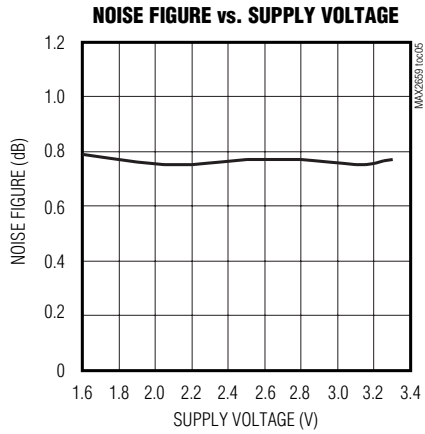
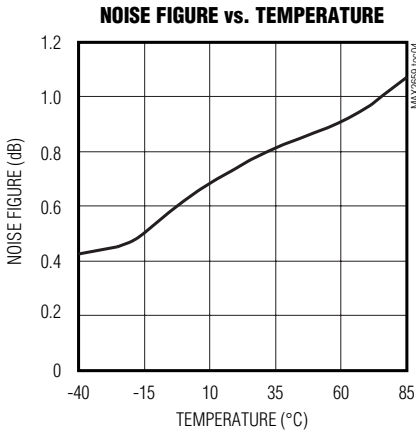
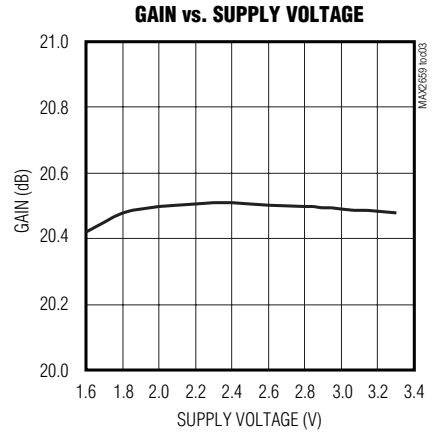
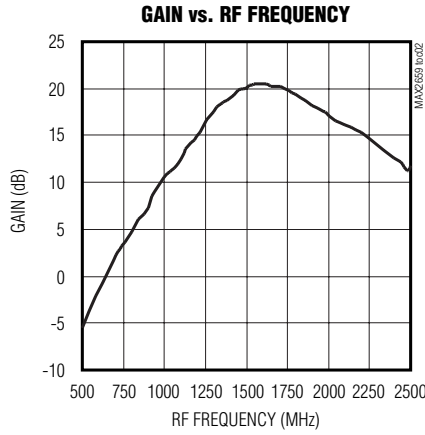
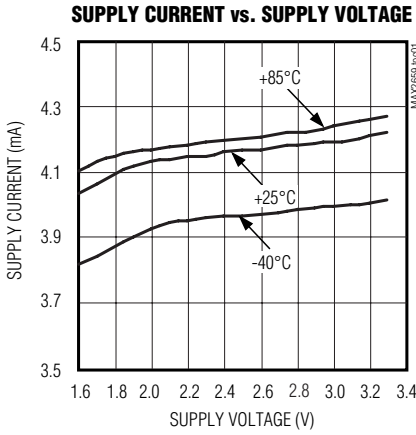

GPS/GNSS Low-Noise Amplifier

Typical Operating Characteristics (continued)

(MAX2659 EV kit; Typical values are at $V_{CC} = 2.85V$, $T_A = +25^\circ C$, and $f_{RFIN} = 1575.42MHz$, unless otherwise noted.)

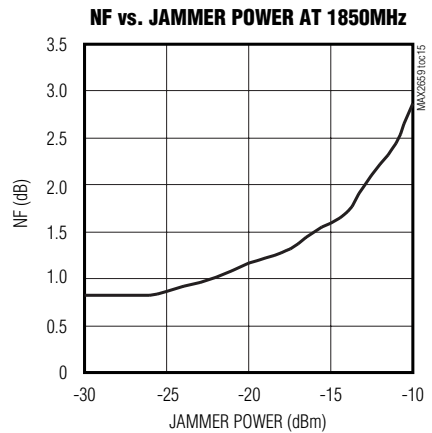
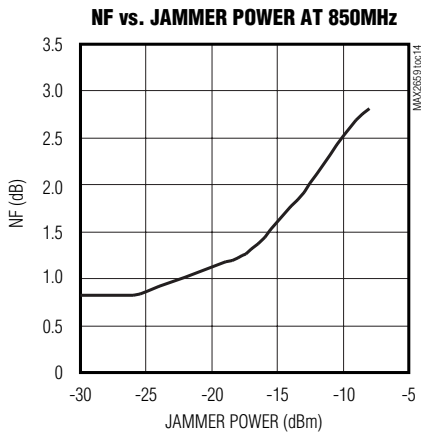
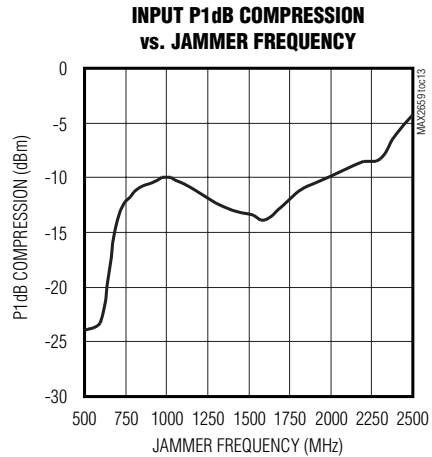
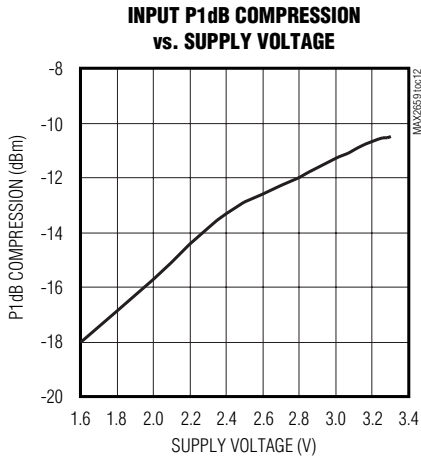
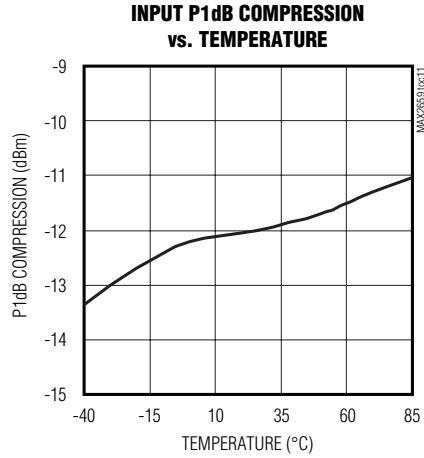
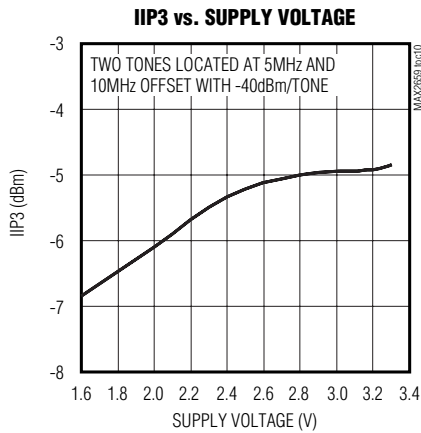

GPS/GNSS Low-Noise Amplifier

MAX2659

Pin Description

PIN	NAME	FUNCTION
1, 2	GND	Ground. Connect to the PCB ground plane.
3	RFIN	RF Input. Requires a DC-blocking capacitor and external matching components.
4	V _{CC}	Supply Voltage. Bypass to ground with a 33nF capacitor as close as possible to the IC.
5	SHDN	Shutdown Input. A logic-low disables the device.
6	RFOUT	RF Output. RFOUT is internally matched to 50Ω and incorporates an internal DC-blocking capacitor.

Detailed Description

The MAX2659 is an LNA designed for GPS L1, GALILEO, and GLONASS applications. The device features a power-shutdown control mode to eliminate the need for an external supply switch. The device achieves a 20.5dB gain and an ultra-low-noise figure of 0.8dB. The MAX2659 consumes approximately 4.1mA while providing a IP_{1dB} of -12dBm and an IIP₃ of -5dBm.

Input and Output Matching

The MAX2659 requires an off-chip input matching. Only a 6.8nH inductor in series with a DC-blocking capacitor is needed to form the input matching circuit. The *Typical Application Circuit* diagram shows the recommended input-matching network. These values are optimized for the best simultaneous gain, noise figure, and return loss performance. Table 1 lists typical device S₁₁ values. The MAX2659 integrates an on-chip output matching to 50Ω at the output, eliminating the need for external matching components.

Table 1. Typical S₁₁ Values

FREQUENCY (MHz)	REAL S ₁₁	IMAGINARY S ₁₁
1000	-0.58	-j0.52
1100	-0.68	-j0.356
1200	-0.74	-j0.16
1300	-0.74	j0.036
1400	-0.676	j0.22
1500	-0.56	j0.36
1575	-0.47	j0.415
1600	-0.44	j0.43
1700	-0.36	j0.467
1800	-0.3	j0.51
1900	-0.228	j0.567
2000	-0.14	j0.622

Shutdown

The MAX2659 includes a shutdown feature to turn off the entire chip. Apply a logic high to SHDN pin to place the part in the active mode and a logic low to place the part in the shutdown mode.

Applications Information

A properly designed PC board (PCB) is essential to any RF microwave circuit. Use controlled-impedance lines on all high-frequency inputs and outputs. Bypass V_{CC} with decoupling capacitors located close to the device. For long V_{CC} lines, it may be necessary to add decoupling capacitors. Locate these additional capacitors further away from the device package. Proper grounding of the GND pins is essential. If the PCB uses a top-side RF ground, connect it directly to the GND pins. For a board where the ground is not on the component layer, connect the GND pins to the board with multiple vias close to the package.

Chip Information

PROCESS: SiGe BiCMOS

Package Information

For the latest package outline information and land patterns, go to www.maxim-ic.com/packages.

PACKAGE TYPE	PACKAGE CODE	DOCUMENT NO.
6 μDFN	L611-2	21-0147

GPS/GNSS Low-Noise Amplifier

Revision History

REVISION NUMBER	REVISION DATE	DESCRIPTION	PAGES CHANGED
0	4/07	Initial release	—
1	5/08	Updated Digital Input-Logic High specification and added RFIN DC Voltage specification in <i>DC Electrical Characteristics</i> table	2

Maxim cannot assume responsibility for use of any circuitry other than circuitry entirely embodied in a Maxim product. No circuit patent licenses are implied. Maxim reserves the right to change the circuitry and specifications without notice at any time.

Maxim Integrated Products, 120 San Gabriel Drive, Sunnyvale, CA 94086 408-737-7600 _____ **6**